

# ALDRIDGE

MASTERS OF SECURITY DISTRIBUTION



## MORTICE BLANK CATALOGUE

# ALDRIDGE

MASTERS OF SECURITY DISTRIBUTION

## WELCOME TO ALDRIDGE

Aldridge Security are a family owned and run company who have been the UK's leading supplier of security products to the Locksmith, Architectural Ironmonger & Installer for over 60 years.

### Superior Customer Service

Our friendly Customer Service Team are highly trained and offer a wealth of expertise and product advice to our customers.

All team members undertake on-going product training to ensure that they can offer customers the very highest level of in-house knowledge.

State-of-the-art communications are in place to ensure we are available to service your needs quickly and efficiently.



### Extensive Product Range

With over 13,000 product lines, available from two branches you can be sure of getting the right product, at the right price, right on time.

Our extensive range includes, not only traditional locksmith products and architectural ironmongery, but also up-to-the-minute access control products and our comprehensive Asec range.



### Fast Efficient Service

Orders can be taken by our Sales offices between 8.00am to 5.00pm Monday to Friday. We have a wide range of delivery options available including delivery to Northern Ireland and the Irish Republic.

Our Showrooms, situated at both our London and Manchester branches, are also open during business hours offering a fast, efficient and knowledgeable service.



### Excellent Customer Support

Our comprehensive range of support material includes price lists, catalogues, supplier literature, new product information, promotions and CD-Rom catalogues.

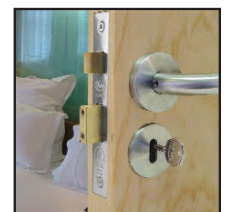
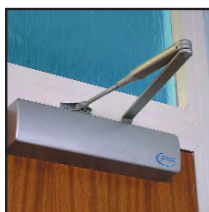

Email us at [sales@aldridgesecurity.co.uk](mailto:sales@aldridgesecurity.co.uk)

# WELCOME TO THE MORTICE GUIDE

---

Welcome to the new Mortice Blank Catalogue in which you will find full details of our current range of mortice blanks and related products.

Aldridge are a dedicated key cutter's supplier with over 3,000 types of key blanks, key boards, Silca machines, tools and accessories, support material held in stock.

Mortice blank selection is not an easy art to master especially with the number of different suppliers and types of mortice blanks available.

This reference guide has been written to assist you in selecting the appropriate blank by bringing together a scale image of every mortice blank we stock into a single, easy-to-reference document.



Email us at [sales@aldrigesecurity.co.uk](mailto:sales@aldrigesecurity.co.uk)



# HOW TO USE THIS DIRECTORY

The images contained within this catalogue are 1:1 scale so that your blank can be held against the pages to identify it. You can find blanks by looking in either the contents for the category or in the index for the blank reference.

Aldridge has taken great care in measuring all the keys inside this guide, and used the industry standard tools to gain information. For more support on finding your requirements contact are sales office for details.

**Gauge measurements**

**Product Section**

**Product Type**

**Product Codes**

**Product Description**

**New Product Section Starting**

**Measurements**

**Actual size images**

**Profiles**

**Page Numbers**

**Product Section**

Product Code	Description	Gauge
A31065	6GC	6
A31072	7GC	7
A31088	8GC	8
A31093	9GC	9

Product Code	Description	Gauge
A31080	10GT2	10
A31081	10GT2	9

Product Code	Description	Gauge
A31092	8GC MED	8
A31093	9GC MED	9
A31090	10GC MED	10
A31094	11GC MED	11
A31091	12GC MED	12

Product Code	Description	Gauge
A31082	10GC LONG	10
A31083	11GC LONG	11
A31084	7GC LONG	7
A31085	8GC LONG	8
A31086	9GC LONG	9

Product Code	Description	Gauge
A31269	10GC	10
A31268	11GC	11
A31270	9GC	9

Product Code	Description	Gauge
LR35	6605	8

# HOW TO USE THIS DIRECTORY

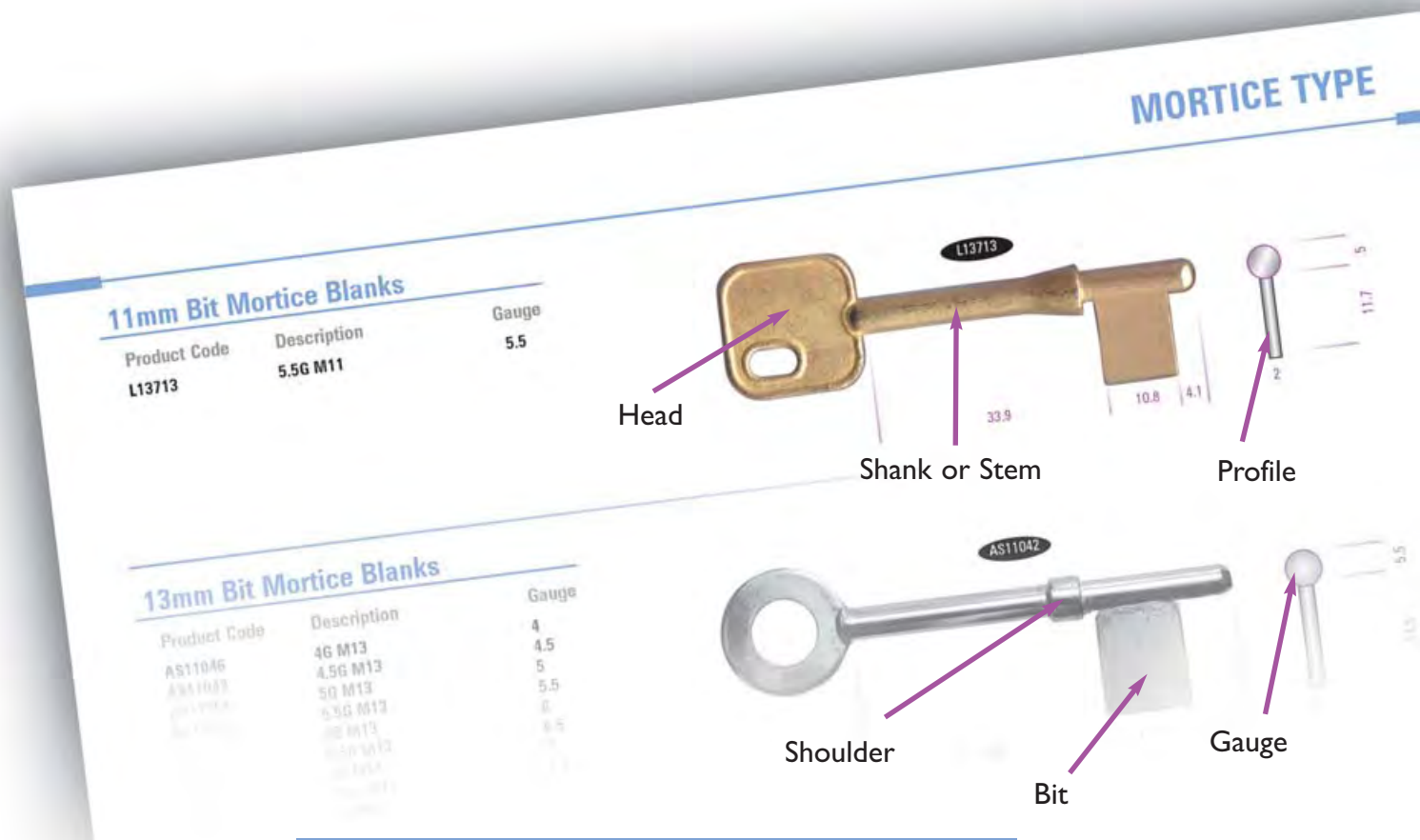

## Profile Variants

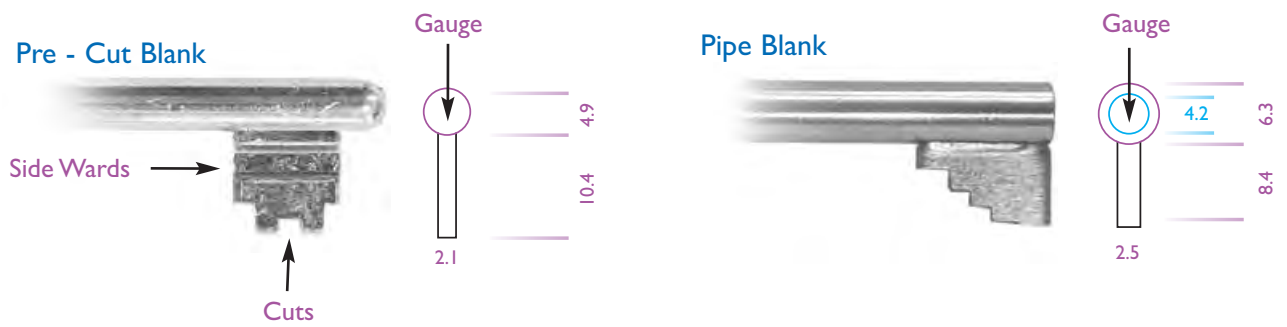

## Gauge table

Gauge	0	1	2	2.5	3	3.5	4	4.5	5	5.5	6	6.5	7	7.5	8	9	10	11	12	13	14
Inch	0.324	0.300	0.276	0.264	0.252	0.242	0.232	0.222	0.212	0.202	0.192	0.184	0.176	0.168	0.160	0.144	0.128	0.116	0.104	0.092	0.80
	0.315	0.295		0.256		0.236		0.216		0.196		0.177		0.168	0.157	0.138	0.118		0.098		0.78
mm	8.230	7.600	7.000	6.710	6.400	6.150	5.890	5.640	5.380	5.130	4.880	4.670	4.470	4.270	4.060	3.660	3.250	2.950	2.640	2.370	2.03
	8.000	7.500		6.500		6.000		5.500		5.00		4.500		4.270	4.000	3.500	3.000		2.500		2.00

Every care has been taken to ensure that the information in this document is accurate at time of print however we cannot accept any liability for incorrect information. We reserve the right to change the specification of the products without prior notification.

# MAIN INDEX



## Mortice Blanks

Mortice (Type) 1  
Manufacturer (MFR) 1 - 10



## Slip Bits

Slip Bits) 23



## Rim Blanks

Rim (Type) 10  
Rim Manufacturer (MFR) 11 - 10



## Pipe Safe

Pipe Safe - (MFR) 24



## Gate Blanks

Gate Blanks 11 - 12

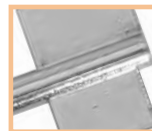

## Double Bitted Safe

Double bitted Safe - (Type) 25 - 26  
Double bitted Safe - (MFR) 26 - 28



## Pre - Cut Blanks

Pre - Cut Mortice 12 - 14  
Pre - Cut Rim 15 - 16  
Pre - Cut Padlock 12 - 14  
Pre - Master Keys 15 - 16  
Pre - Cut Wardrobe 12 - 14



## Pin Cabinet

Pin Cabinet - (Type) 29



## Pin Padlocks

Pin Padlock - Type 18  
Pin Padlock - MFR 19



## Pipe Cabinet

Pipe Cabinet - (Type) 29 - 31



## Pipe Padlocks

Pipe Padlock - Type 20  
Pipe Padlock - MFR 20



## Maleable Iron

Maleable Iron 32 - 35

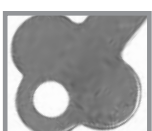

## Flat Steel Blanks

Flat Steel - Type 21



## Presentation

Presentation 36



## Pin Safe

Pin Safe - (Type) 21 - 22  
Pin Safe - (MFR) 23 - 24

### 11mm Bit Mortice Blanks

Product Code	Description	Gauge
LI3713	5.5G M11	5.5



### 13mm Bit Mortice Blanks

Product Code	Description	Gauge
ASI1046	4G M13	4
ASI1042	4.5G M13	4.5
ASI1058	5G M13	5
ASI1052	5.5G M13	5.5
ASI1067	6G M13	6
ASI1063	6.5G M13	6.5
ASI1073	7G M13	7
ASI1071	7.5G M13	7.5
ASI1090	8G M13	8



### 16mm Bit Mortice Blanks

Product Code	Description	Gauge
ASI1021	2G M16	2
ASI1026	3G M16	3
ASI1023	3.5G M16	3.5
ASI1047	4G M16	4
ASI1043	4.5G M16	4.5
ASI1059	5G M16	5
ASI1055	5.5G M16	5.5
ASI1068	6G M16	6
ASI1062	6.5G M16	6.5
ASI1074	7G M16	7
ASI1070	7.5G M16	7.5
ASI1091	8G M16	8



### 2L Warded Mortice Blanks

Product Code	Description	Gauge
ASI1104	KB190 LH	5.5
ASI1105	KB190 RH	5.5

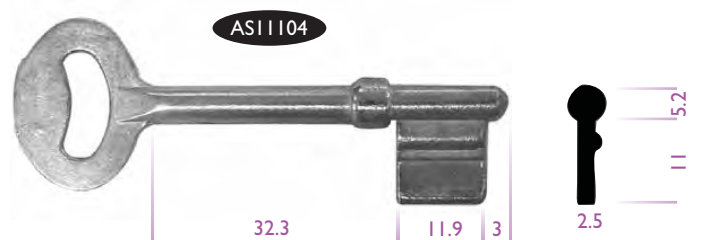

### MORTICE - MFR

### Ace Mortice Blank

Product Code	Description
ASI1095	ACEM

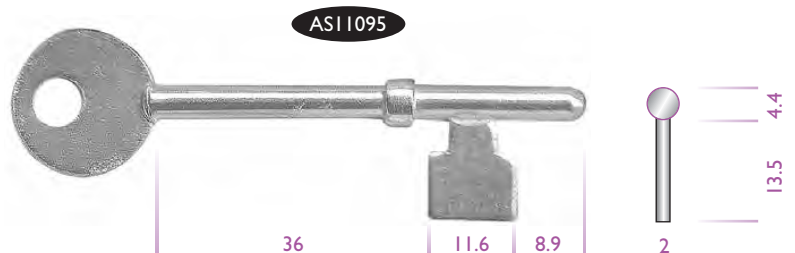

## Asec Mortice Blank

Product Code	Description	Gauge
ASI1098	ASEC 3L/5L/BS5L	5



## Aldridge / Walsall Lock BS Mortice Blank

Product Code	Description	Gauge
A1321	5L-BS - GEN	5



## Chubb 3G114 Mortice Blanks

Product Code	Description	Gauge
3698	K722 3G114 - GEN	5
7000	CHC 3G114	5
ASI1032	3G114M - EB STEEL	5
ASI1034	3G114M - NP STEEL	5
ASI1033	3G114M - PB	5
ASI1035	3G114RIM	5

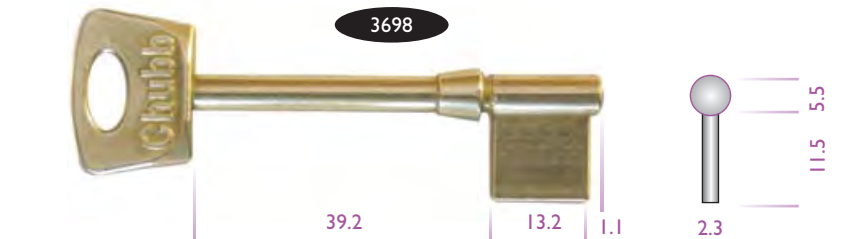

## Chubb 3G110 Mortice Blanks

Product Code	Description	Gauge
3693	K521 3G110 - GEN	5
7127	CHL 3G110	5
ASI1258	3G110 - EB STEEL	5
ASI1031	3G110R EB	5
ASI1029	3G110M PB	5
ASI1028	3G110M K429 MASTER	5
ASI1030	3G110R	5



## Elementa Mortice Blank

Product Code	Description	Gauge
ASI1102	ELEMENTA	2

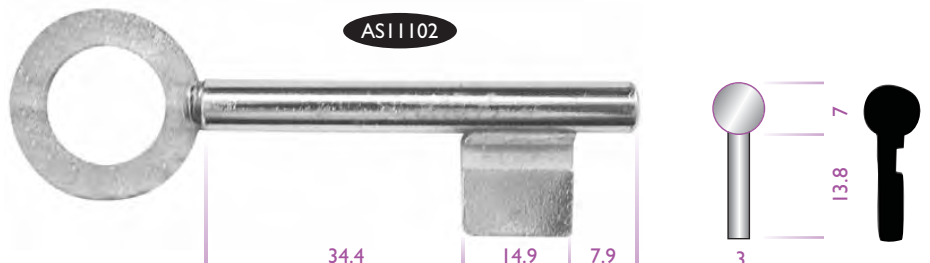

## Era Economy 2L Mortice Blanks

Product Code	Description
LI1781	60556 LH - GEN
LI1782	60556 RH - GEN

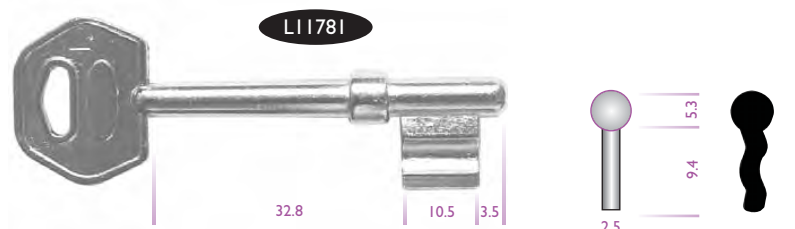



**Era Endurance Mortice Blank**

Product Code	Description	Gauge
AS11101	E104M	7

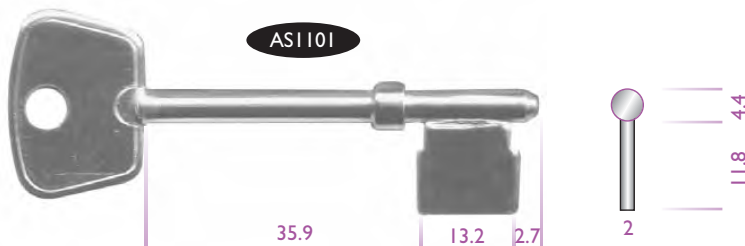

**Era Invincible Mortice Blanks**

Product Code	Description	Gauge
8796	608 06 - GEN	5
L5701	6ERI	5



**Era Profit / New Viscount Mortice Blanks**

Product Code	Description	Gauge
L8478	60906 PROFIT - GEN	7
AS11064	60906 PROFIT	7



**Era Old Viscount Mortice Blanks**

Product Code	Description	Gauge
L679	60756 OLDVISCOUNT - GEN	7
AS11106	VISCOUNT M	7



**Erebus Mortice Blank**

Product Code	Description	Gauge
AS11087	8G EREBUS	8



**Euro Mortice Blanks**

Product Code	Description	Blank To Suit
AS11306	ALI	A17 - A24
AS11307	ALO	A1 - A8
AS11308	ARI	A25 - A32
AS11309	ARO	A19 - A16
AS11302	CLI	C7, C12, C13, C14, C20
AS11304	CLO	C3, C6, C17, C18, C19
AS11303	CRI	C1, C6, C17, C18, C19
AS11305	CRO	C8, C10, C11, C15, C16



## Fleet 3510 Mortice Blanks

Product Code	Description
AS11233	3510A
AS11234	3510B
AS11235	3510C
AS11236	3510D
AS11237	3510E
AS11238	3510F



## Gibbons 970 Mortice Blanks

Product Code	Description
AS11239	970G
AS11240	970H
AS11241	970J
AS11242	970K
AS11243	970L

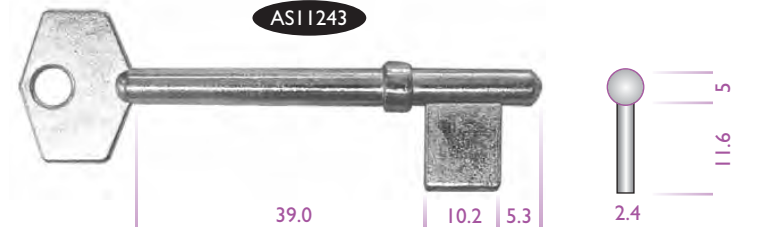

## Gibbons G200 Mortice Blank

Product Code	Description	Gauge
AS11109	G200	8



## Guardian Mortice Blank

Product Code	Description	Gauge
AS11103	GUARDIAN M	6

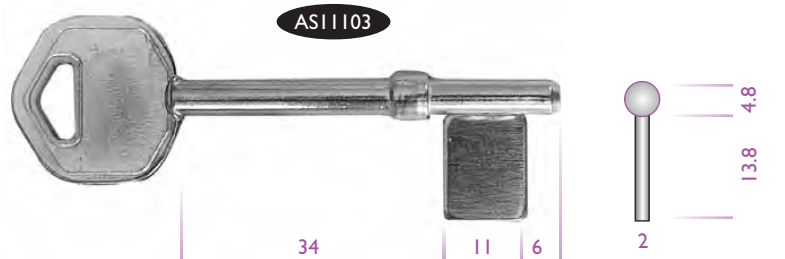

## Ingersoll M6 Mortice Blank

Product Code	Description	Gauge
AS11120	M6	7



## Ingersoll M50/M52 Mortice Blank

Product Code	Description	Gauge
AS11117	M50M	5



### Legge 2378 Mortice Blanks

Product Code	Description	Blank To Suit
AS11295	B1	R1 R7 R13 & R19
AS11296	B2	R2 R8 R14 & R20
AS11297	B3	R3 R9 R15 & R21
AS11298	B4	R4 R10 R16 & R22
AS11299	B5	R5 R11 R17 & R23
AS11300	B6	R6 R12 R18 & R24



### Legge 2645 Mortice Blank

Product Code	Description	Gauge
L5324	2645 BKBY 5L - GEN	5

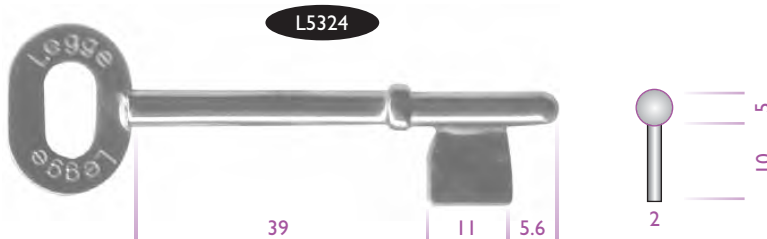

### Legge 5641/5642 BS Mortice Blanks

Product Code	Description	Gauge
1579	5641 BKB 5L - GEN	4.5
AS11060	5641 5LM	4.5



### Legge H Series Mortice Blanks

Product Code	Description
3491	H SERIES BKB 1062 - GEN
AS11132	H NEW M
AS11133	H OLD M



### Legge LV Series Mortice Blanks

Product Code	Description	Gauge
L1362	LV SERIES BKB 3260 - GEN	5.5
AS11114	LV SERIES	5.5



## Merchant Mortice Blank

Product Code	Description	Gauge
AS11122	MERCHANT BRASS	5



## Morgan Mortice Blanks

Product Code	Description	Gauge
L13261	TM9-197D/S 5L MORGAN - GEN	5.5



## Securefast Mortice Blanks

Product Code	Description	Gauge
L8712	SECUREFAST BS - GEN	7
AS11125	SECUREFAST 5L	7



## Securefast Mortice Blank

Product Code	Description	Gauge
L8712	SECUREFAST BS - GEN	7



## Union 2188 Mortice Blanks

Product Code	Description
4238	KB428 No.1 2188 - GEN
4244	KB428 No.2 2188 - GEN
4248	KB428 No.3 2188 - GEN
4257	KB428 No.4 2188 - GEN
4261	KB428 No.5 2188 - GEN
4265	KB428 No.6 2188 - GEN
4272	KB428 No.7 2188 - GEN
4274	KB428 No.8 2188 - GEN
4279	KB428 No.9 2188 - GEN
4282	KB428 No.10 2188 - GEN



Note: Blank profile No. in cut key reference eg M101L, M106I, M179L

## Union 2201/2234 5L & BS Mortice Blanks

Product Code	Description	Gauge
10376	KB430 - GEN	5
AS11111	KB430M	5

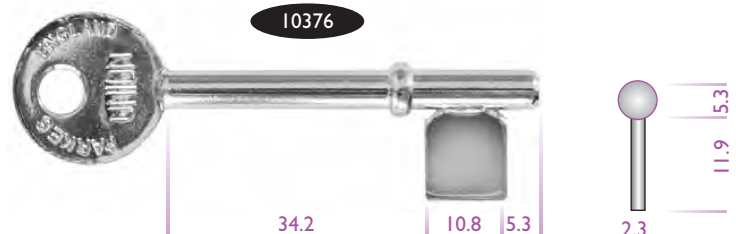



### Union 2237 3L MK Mortice Blanks

Product Code	Description	Gauge
4229	KB483 UNION 2237 3L MASTER - GEN	5
ASI1040	3LM PLAIN BIT	5

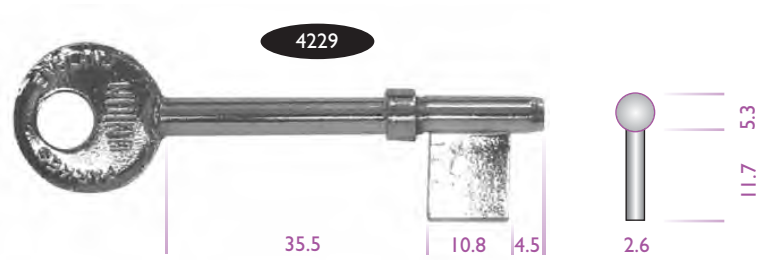

### Union 2277 3L Mortice Blanks

Product Code	Description	Gauge
8584	2UN2 BRASS	5
ASI1041	3LM WITH WARD	5
ASI1039	3LR	5
4219	KB436 - 3L - GEN	5



### Union 2295 Mortice Blanks

Product Code	Description
ASI1016	M9H - M14H
ASI1014	M15H - M20H
ASI1015	M21H - M26H
ASI1017	M27H - M32H
ASI1018	M33H - M36H
ASI1019	M37H - M40H



### Union 2297 4 Detainer Mortice Blank

Product Code	Description	Gauge
ASI1051	4LM	5



### Union APG KYK Mortice Blanks

Product Code	Description	Gauge
4223	KB145 KYK APG - GEN	5
ASI1126	KYK APG COPY	5

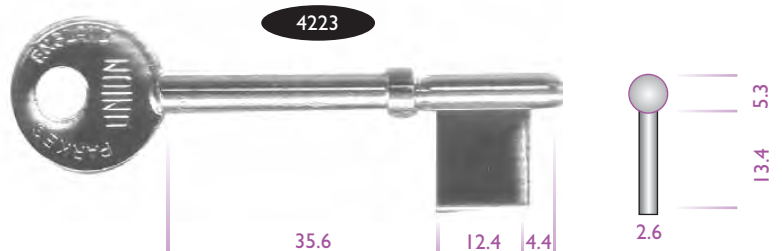

### Union 2297 4 Detainer Mortice Blank

Product Code	Description	Gauge
4224	KB482 4L - GEN	5

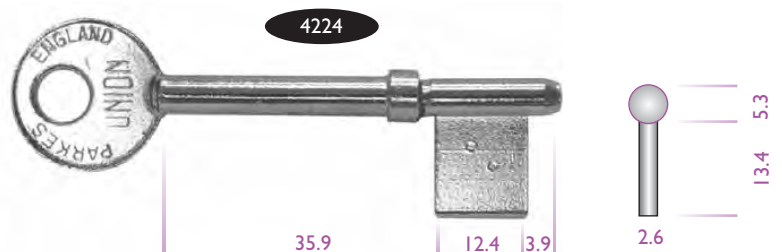

## Union BGA Panel Lock Blank

Product Code	Description	Gauge
ASI1096	BGA NEW	5



## Wellington Fort Mortice Blank

Product Code	Description	Gauge
ASI1005	FORTM	5.5



## Willenhall Bulwark Mortice Blank

Product Code	Description	Gauge
ASI1115	BULWARK M1	7



## Willenhall M5 Mortice Blank

Product Code	Description	Gauge
ASI1107	G12M	5.5

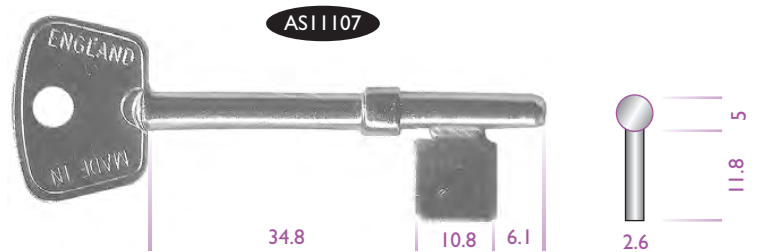

## Willenhall M8 Mortice Blank

Product Code	Description	Gauge
ASI1108	G13M	7



### Worrell (Spaceguard) Mortice Blanks

Product Code	Description	Gauge
L5397	4.5G WORRAL - GEN	4.5
3748	7G WORRAL - GEN	7

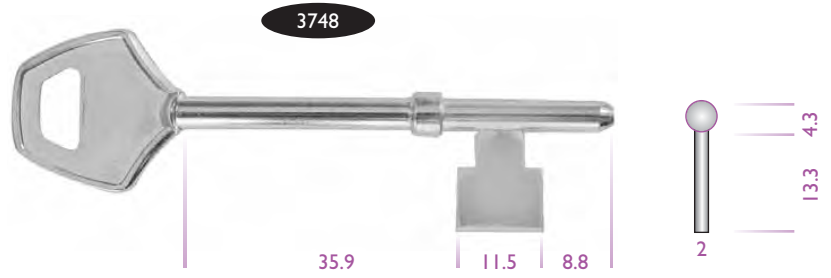

### Yale M320 Mortice Blanks

Product Code	Description	Gauge
L1965	M320 - GEN	5
AS11116	M320M	5



### Yale M555 Mortice Blanks

Product Code	Description	Gauge
AS11118	M555M	5.5

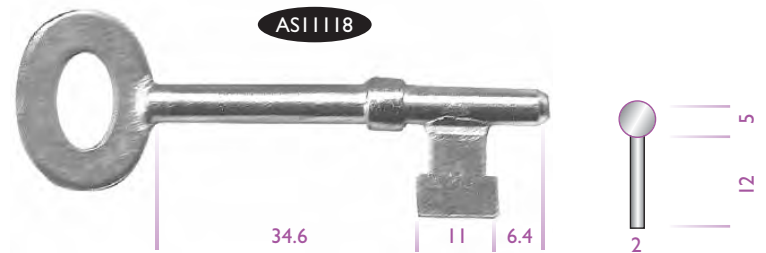

### Yale M560/562 LPKB Mortice Blanks

Product Code	Description	Gauge
AS11119	M560M	5



### Yale M900 Mortice Blank

Product Code	Description	Gauge
AS11121	M900M	5



## Yale M560/562 LPKB Mortice Blanks

Product Code	Description	Gauge
L4798	LPKB - GEN	5



## RIM - TYPE

### 16mm Bit Rim Blanks

Product Code	Description	Gauge
AS11036	3G R16	3
AS11050	4G R16	4
AS11044	4.5G R16	4.5
AS11061	5G R16	5
AS11053	5.5G R16	5.5

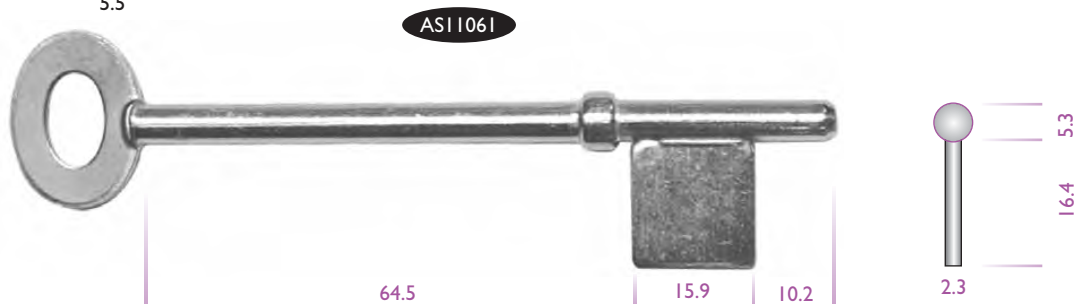

### 19mm Bit Rim Blanks

Product Code	Description	Gauge
AS11009	1G R19	1
AS11022	2G R19	2
AS11037	3G R19	3
AS11025	3.5G R19	3.5
AS11049	4G R19	4
AS11045	4.5G R19	4.5
AS11057	5G R19	5
AS11054	5.5G R19	5.5
AS11066	6G R19	6
AS11075	7G R19	7

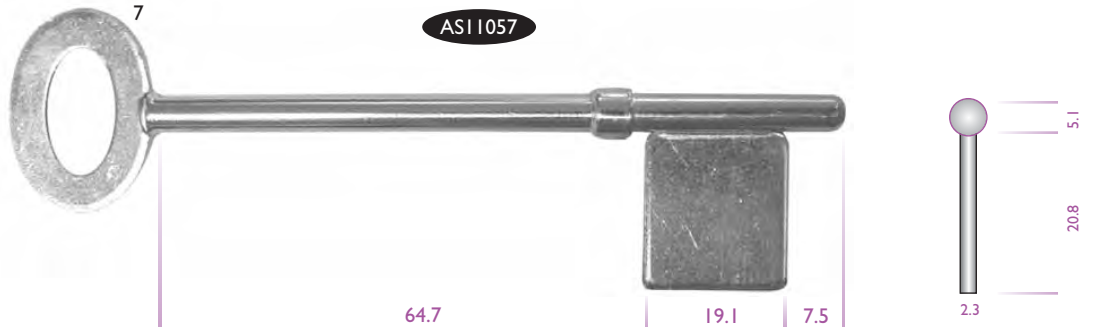

### Chubb 3G I 10 5L Rim Blank

Product Code	Description	Gauge
AS11031	3G I 10 R EB	5





### Chubb 3G I I4 5L Rim Blank

Product Code	Description	Gauge
AS11035	3G I I4R EB	5



### Union I439 3L Rim Blank

Product Code	Description	Gauge
L1407	KB144 3L RIM - GEN	2.5



### Union I445 Rim Blank

Product Code	Description	Gauge
L1406	KB150 3L RIM - GEN	5



### Union MM 3L Rim Blank

Product Code	Description	Gauge
AS11039	Union 2277	5



### 19mm Gate Blanks

Product Code	Description	Gauge
9569	1GG	1
AS11020	2GG2	2
AS11027	3GG	3
AS11024	3.5GG	3.5
AS11048	4GG	4
AS11056	5GG	5

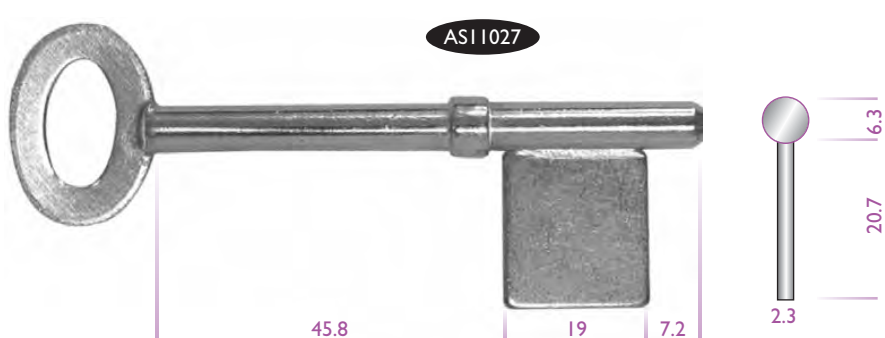

### GATE

**Boswick No I Ward Gate Blank**

Product Code	Description	Gauge
AS1123	BOSG	3.5



**PRE - CUT MORTICE**

**Asec Pre-Cut Mortice Keys**

Product Code's

AS101	AS118	AS135	AS152	AS169	AS186
AS102	AS119	AS136	AS153	AS170	AS187
AS103	AS120	AS137	AS154	AS171	AS188
AS104	AS121	AS138	AS155	AS172	AS189
AS105	AS122	AS139	AS156	AS173	AS190
AS106	AS123	AS140	AS157	AS174	AS191
AS107	AS124	AS141	AS158	AS175	AS192
AS108	AS125	AS142	AS159	AS176	AS193
AS109	AS126	AS143	AS160	AS177	AS194
AS110	AS127	AS144	AS161	AS178	AS195
AS111	AS128	AS145	AS162	AS179	AS196
AS112	AS129	AS146	AS163	AS180	AS196
AS113	AS130	AS147	AS164	AS181	AS197
AS114	AS131	AS148	AS165	AS182	AS198
AS115	AS132	AS149	AS166	AS183	AS199
AS116	AS133	AS150	AS167	AS184	AS200
AS117	AS134	AS151	AS168	AS185	

Blanks

AS201 (A)	AS201 - AS120
AS121 (B)	AS121 - AS140
AS141 (C)	AS141 - AS160
AS161 (D)	AS161 - AS180
AS181 (E)	AS181 - AS200

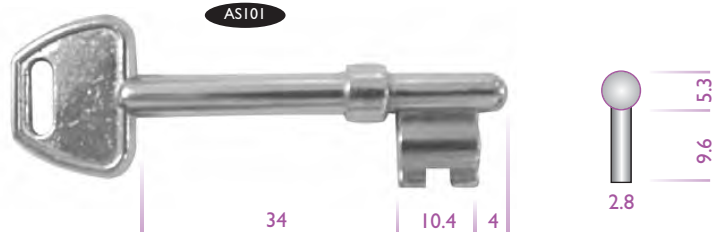

**Euro Pre-Cut Mortice Keys**

Product Code	Description	Product Code	Description
AS11134	A1 KEY	AS11142	A17 KEY
AS11145	A2 KEY	AS11143	A18 KEY
AS11156	A3 KEY	AS11144	A19 KEY
AS11160	A4 KEY	AS11146	A20 KEY
AS11161	A5 KEY	AS11147	A21 KEY
AS11162	A6 KEY	AS11148	A22 KEY
AS11163	A7 KEY	AS11149	A23 KEY
AS11164	A8 KEY	AS11150	A24 KEY
AS11165	A9 KEY	AS11151	A25 KEY
AS11135	A10 KEY	AS11152	A26 KEY
AS11136	A11 KEY	AS11153	A27 KEY
AS11137	A12 KEY	AS11154	A28 KEY
AS11138	A13 KEY	AS11155	A29 KEY
AS11139	A14 KEY	AS11157	A30 KEY
AS11140	A15 KEY	AS11158	A31 KEY
AS11141	A16 KEY	AS11159	A32 KEY



**Gibbons 900 Pre-Cut Mortice Keys**

Product Code	Description
AS11167	A1 KEY 900
AS11168	A2 KEY 900
AS11169	A3 KEY 900
AS11170	A4 KEY 900
AS11171	A5 KEY 900
AS11172	A6 KEY 900
AS11173	B1 KEY 900
AS11174	B2 KEY 900
AS11175	B3 KEY 900
AS11176	B4 KEY 900
AS11177	B5 KEY 900
AS11178	B6 KEY 900



Legge 2378 Pre-Cut Mortice Keys

Product Code	Description	Product Code	Description
AS11194	R1 LEG	AS11203	R18 LEG
AS11205	R2 LEG	AS11204	R19 LEG
AS11211	R3 LEG	AS11206	R20 LEG
AS11212	R4 LEG	AS11207	R21 LEG
AS11213	R5 LEG	AS11208	R22 LEG
AS11214	R6 LEG	AS11210	R24 LEG
AS11215	R7 LEG		
AS11216	R8 LEG		
AS11217	R9 LEG		
AS11195	R10 LEG		
AS11196	R11 LEG		
AS11197	R12 LEG		
AS11198	R13 LEG		
AS11199	R14 LEG		
AS11200	R15 LEG		
AS11201	R16 LEG		
AS11202	R17 LEG		
AS11209	R23 LEG		

  

Blanks			
Product Code	Blank Code	Blank Description	Blank Description
AS11295	B1	R1 R7 R13 & R19	
AS11296	B2	R2 R8 R14 & R20	
AS11297	B3	R3 R9 R15 & R21	
AS11298	B4	R4 R10 R16 & R22	
AS11299	B5	R5 R11 R17 & R23	
AS11300	B6	R6 R12 R18 & R24	



Union 2277MM Pre-Cut Mortice Keys

Product Code	Description	Product Code	Description	Product Code	Description	Product Code	Description
4117	M101M	4222	M130M	4339	M159M	4503	M189M
4119	M102M	4226	M131M	4344	M160M	4505	M190M
4120	M103M	4227	M132M	4348	M161M	4508	M191M
4122	M104M	4231	M133M	4351	M162M	4511	M192M
4123	M105M	4234	M134M	4355	M163M	4515	M193M
4125	M106M	4236	M135M	4359	M164M	4519	M194M
4128	M107M	4239	M136M	4362	M165M	4523	M195M
4133	M108M	4242	M137M	4366	M166M	4526	M196M
4138	M109M	4246	M138M	4370	M167M	4530	M197M
4151	M110M	4251	M139M	4373	M168M	4533	M198M
4154	M111M	4256	M140M	4377	M169M	4541	M199M
4160	M112M	4260	M141M	4380	M170M	4545	M200M
4164	M113M	4264	M142M	4382	M171M	L1405	M101M M200M KEY SET
4166	M114M	4275	M143M	4385	M172M		<b>(100 Keys)</b>
4170	M115M	4281	M144M	4388	M173M		
4174	M116M	4283	M145M	4393	M174M		
4177	M117M	4285	M146M	4400	M175M		
4180	M118M	4291	M147M	4406	M176M		
4183	M119M	4295	M148M	4411	M177M		
4185	M120M	4299	M149M	4414	M178M		
4186	M121M	4303	M150M	4418	M179M		
4188	M122M	4305	M151M	4423	M180M		
4190	M123M	4308	M152M	4427	M181M		
4194	M124M	4309	M153M	4430	M182M		
4198	M125M	4318	M154M	4434	M183M		
4200	M126M	4321	M155M	4440	M184M		
4202	M127M	4325	M156M	4443	M185M		
4217	M128M	4329	M157M	4447	M186M		
4220	M129M	4333	M158M	4464	M187M		
				4495	M188M		

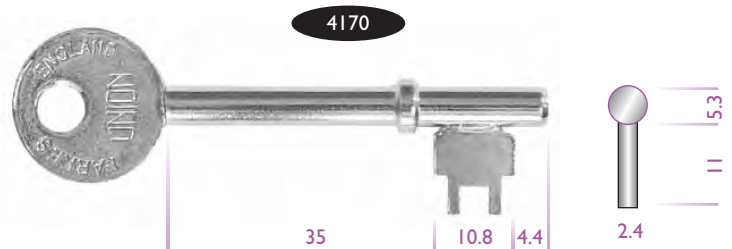

## Union 2277MM Pre-Cut Mortice Keys

Product Code	Description	Product Code	Description
4077	M1M	4095	M19M
LI1084	M2M	4096	M20M
4079	M3M	4097	M21M
4080	M4M	4098	M22M
4081	M5M	4099	M23M
4082	M6M	4100	M24M
4083	M7M	4101	M25M
4084	M8M	4102	M26M
4085	M9M	4103	M27M
4086	M10M	4104	M28M
LI1085	M11M	4105	M29M
4088	M12M	4106	M30M
4089	M13M	4107	M31M
4090	M14M	4108	M32M
4091	M15M	4109	M33M
4092	M16M	4110	M34M
4093	M17M	4115	M35M
4094	M18M	4116	M36M

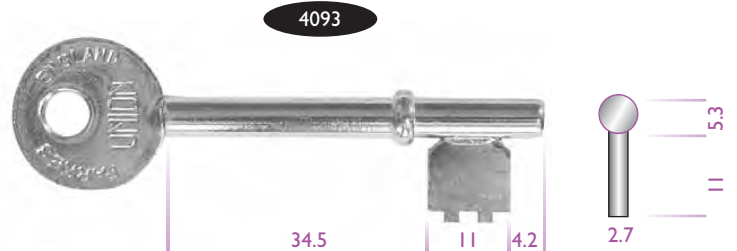

## Union MN & MH Pre-Cut Mortice Keys

Product Code	Description	Product Code	Description
4045	M9H	4065	M29H
4046	M10H	4066	M30H
4047	M11H	4067	M31H
4048	M12H	4068	M32H
4049	M13H	4069	M33H
4050	M14H	4070	M34H
4051	M15H	4071	M35H
4052	M16H	4072	M36H
4053	M17H	4073	M37H
4054	M18H	4074	M38H
4055	M19H	4075	M39H
4056	M20H	4076	M40H
4057	M21H	4036	M1N
4058	M22H	4037	M2N
4059	M23H	4038	M3N
4060	M24H	4040	M4N
4061	M25H	4041	M5N
4062	M26H	4039	M6N
4063	M27H	4043	M7N
4064	M28H	4044	M8N

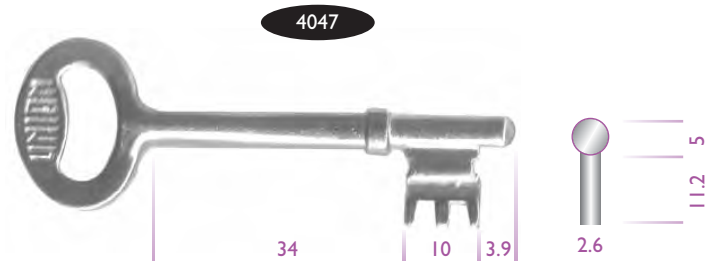

### Blanks

AS11016 (1)	M9H - M14H
AS11017 (2)	M15H - M20H
AS11014 (3)	M21H - M26H
AS11015 (4)	M27H - M32H
AS11018 (5)	M33H - M36H
AS11019 (6)	M37H - M40H

## Yale M246/513 Pre-Cut 2L Mortice Keys

Product Code	Description
AS11179	25
AS11180	26
AS11181	27
AS11182	28
AS11183	29
AS11184	30
AS11185	31
AS11186	32
AS11187	33
AS11188	34
AS11189	35
AS11190	36

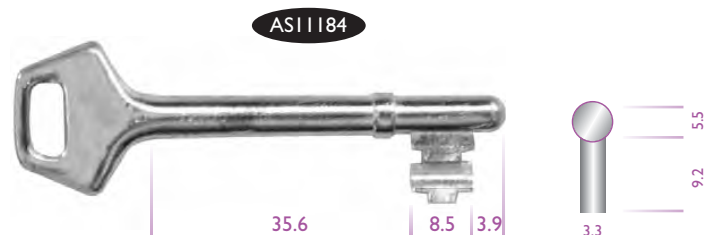



### Fire Brigade FBI Pre-Cut Rim Key

Product Code	Description	Gauge
AS11266	FB1	4



### Fire Brigade FB2 Pre-Cut Rim Keys

Product Code	Description	Gauge
AS11267	FB2	4

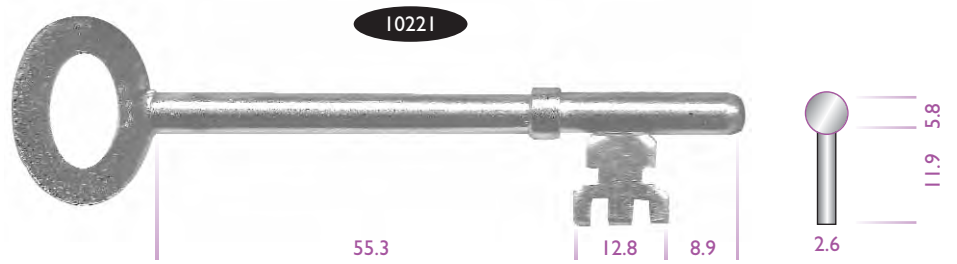

### Fire Brigade FB4 Pre-Cut Rim Keys

Product Code	Description	Gauge
AS11264	FB4	4

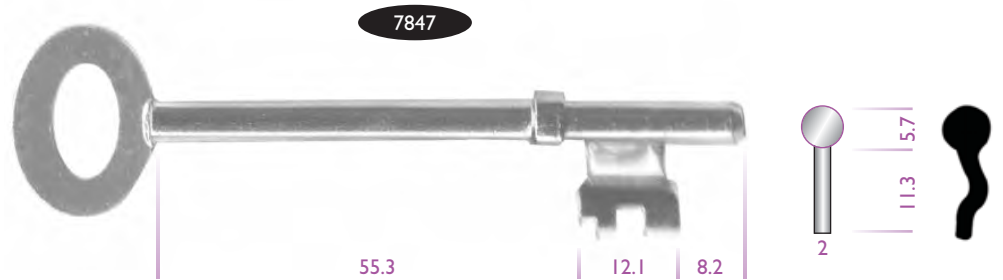

### Gibbons 239 Rim Keys

Product Code	Description	Gauge
AS11218	C13	
AS11219	C14	
AS11220	C15	
AS11221	C16	
AS11222	C17	
AS11223	C18	
AS112224	C19	
AS112225	C20	
AS112226	C21	
AS112227	C22	
AS112228	C23	
AS112229	C24	



# PRE - CUT RIM

## Gibbons 649 Press Lock Pre-Cut Rim Key

Product Code	Description
L1211	649

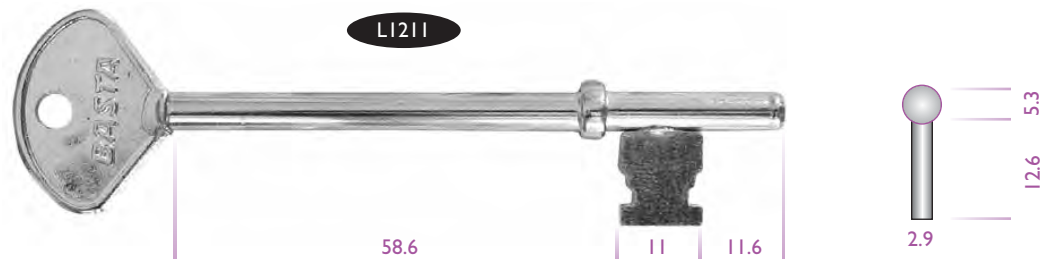

## Radars Rim Key

Product Code	Description	Gauge
AS11124	RADAR RIM KEY	5

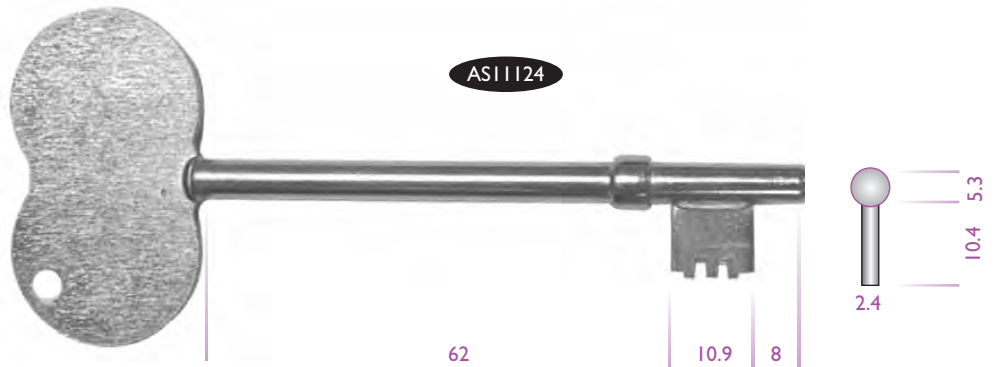

## Union 1445 Pre-Cut Rim Keys

Product Code	Description
4566	R4F
4575	R5F
4579	R6F
4583	R7F
4587	R8F
4596	R9F
4599	R10F
4601	R11F
4604	R12F
4611	R13F

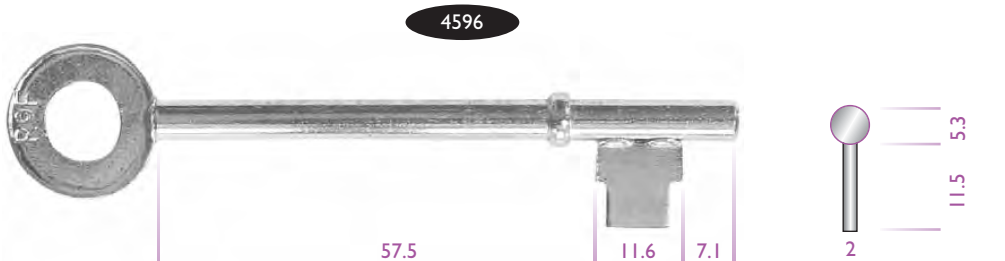

# PRE - CUT PADLOCK

## Fire Brigade FB Pre-Cut Pipe Padlock Key

Product Code	Description	Gauge
AS11191	FB	10



## Fire Brigade FBI I Pre-Cut Pipe Padlock Key

Product Code	Description	Gauge
AS11192	FBI I	7



**Fire Brigade FBI4 Pre-Cut Pipe Padlock Key**

Product Code	Description	Gauge
AS11193	FBI4	8



**Lowe & Fletcher ZA Master Key**

Product Code	Description
2865	ZA

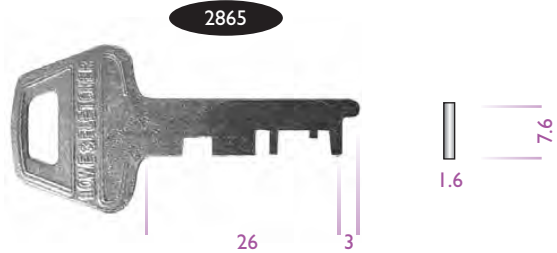

**Lowe & Fletcher ZG Master Key**

Product Code	Description
10440	ZG



**Lowe & Fletcher ZL Master Key**

Product Code	Description
2870	ZL



**Union 3L Stock Master Keys**

Product Code	Description	Gauge
L1418	KKTG UNION MASTER KEYS	
3448	RKGS UNION MASTER KEYS	
3299	RYNU UNION MASTER KEYS	

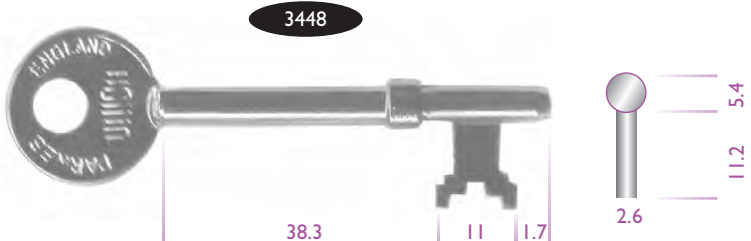

PRE - CUT WARDROBE

**Ashtree Wardrobe Key**

Product Code	Description	Gauge
AS11230	ASHTREE	10

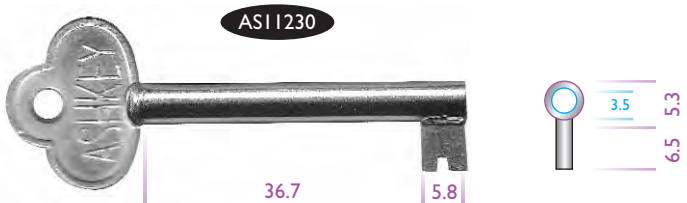

# PRE - CUT WARDROBE

## Asro Wardrobe Key

Product Code	Description	Gauge
ASI1231	ASRO	10



## Ringbow Wardrobe Key

Product Code	Description	Gauge
ASI1232	RINGBOW	10



## PIN PADLOCK - TYPE

### Chubb IK11 Battleship Pin Padlock Blanks

Product Code	Description	Gauge
ASI1010 3686	IK11P STEEL K198 - GEN	6

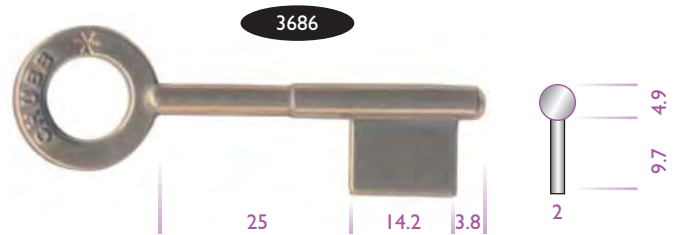

### Chubb IK42 AVA Pin Padlock Blanks

Product Code	Description
5888 L3387	IK42B IK42B GEN



### Safe Guards SG5 Pin Padlock Blank

Product Code	Description
ASI1276	SG 5PIN





### Squire 220 Pin Padlock Blanks

Product Code	Description	Gauge
1065	220 - GEN	8
ASI1244	220 PET PIN	8

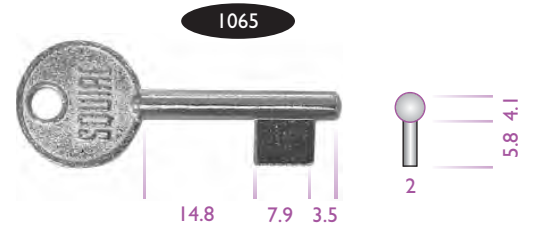

### Squire 440 Pin Padlock Blanks

Product Code	Description	Gauge
1069	440 - GEN	8.5
ASI1245	440 PEF PIN	8.5



### Squire 660 Pin Padlock Blanks

Product Code	Description	Gauge
1074	660 - GEN	6
ASI1246	660 PES PIN	6



### Squire HSI Pin Padlock Blanks

Product Code	Description	Gauge
1079	HSI - GEN	6.5
ASI1110	HSI	6.5

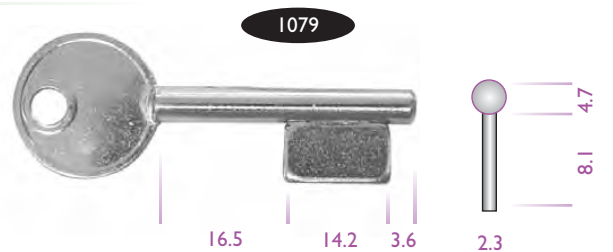

### PIPE PADLOCK - TYPE

#### Asec Pipe Padlock Medium

Product Code	Description	Gauge
ASI1078	8GP MED	8
ASI1079	9GP MED	9
ASI1076	10GP MED	10
ASI1077	11GP MED	11



#### Asec Pipe Padlock Large

Product Code	Description	Gauge
ASI1128	6GP LAR	6
ASI1129	7GPL LAR	7
ASI1130	8GPL LAR	8
ASI1131	9GPL LAR	9
ASI1127	10GPL LAR	10



# PIPE PADLOCK - MFR

## Aldridge CS492 Pipe Padlock Blank

Product Code	Description	Gauge
ASI1099	CS492 8G PADLOCK	8



## Chubb IK21 Cruiser Pipe Padlock Blanks

Product Code	Description
3680	K126 - GEN
ASI1011	IK21P



## Era 212 Big Six Pipe Padlock Blanks

Product Code	Description	Gauge
L00073	61206 - GEN	7
ASI1097	BIG SIX - Steel	7



## Era 975 Pipe Padlock Blanks

Product Code	Description	Gauge
L00074	67506 - GEN	8
ASI1100	975P - Steel	8



## Squire 220 Pipe Padlock Blank

Product Code	Description
ASI1013	220 PIPE



## Walsall Lock Mortice Blank

Product Code	Description	Gauge
L12346	2000 PADLOCK - GEN	8



Flat Steel Blanks

Product Code	Description	Size
ASI1261	FLAT 25	25mm
ASI1006	FLAT 38	38mm
ASI1012	FLAT 50	50mm



PIN SAFE - TYPE

19mm Bit Pin Safe Blanks

Product Code	Description	Gauge
ASI1247	4G S19	4
ASI1248	5G S19	5
ASI1250	5.5G S19	5.5
ASI1251	6G S19	6
ASI1252	6.5G S19	6.5
ASI1262	7G S19	7
ASI1275	7.5G S19	7.5
ASI1253	8G S19	8



25mm Bit Pin Safe Blanks

Product Code	Description	Gauge
ASI1260	5G S25	5
ASI1259	5.5G S25	5.5
ASI1257	6G S25	6
ASI1254	6.5G S25	6.5

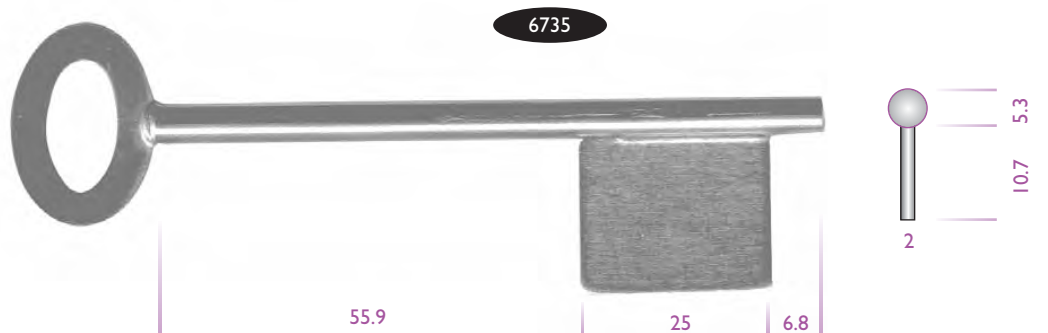

Drawer Pin Safe Blanks

Product Code	Description	Gauge
ASI1256	7GSD	7
ASI1255	8GSD	8



# PIN SAFE - TYPE

## Long 5G Pin Safe Blank

Product Code	Description	Gauge
ASI 1283	5GS LONG	5



## Long 6.5G Pin Safe Blank

Product Code	Description	Gauge
ASI 1282	6.5GS LONG	6.5

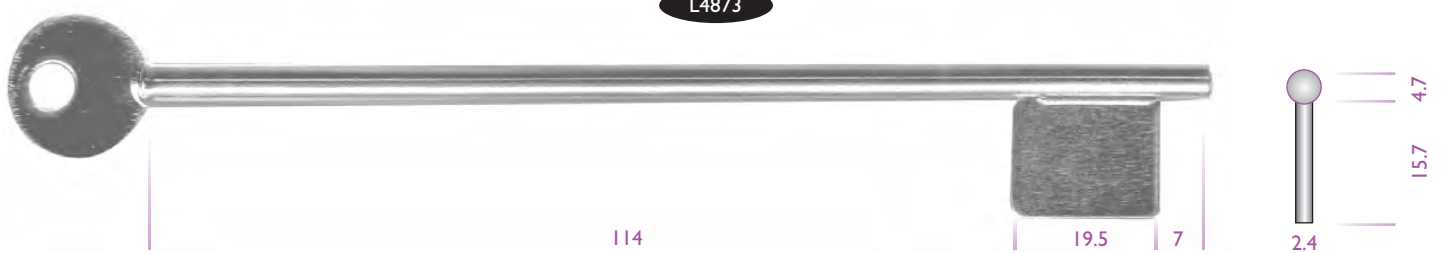

## Extra Long Pin Safe Blank

Product Code	Description	Gauge
ASI 1281	2GS EXTRA LONG	2

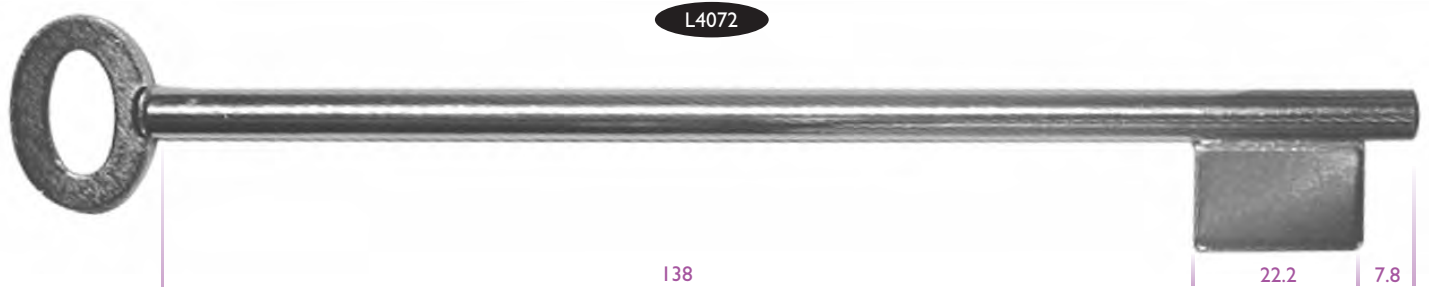

## Extra Long Pin Safe Blank

Product Code	Description	Gauge
ASI 1279	3GS EXTRA LONG	3



Slip Bit CHUI Pin Safe Blank

Product Code	Description
L5272	CHUI DETACHABLE KEY BIT

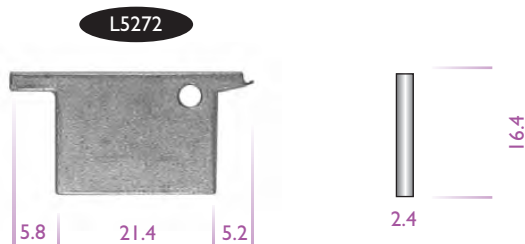

Chatwood Milrier Slip Bit CMDI Pin Safe Blank

Product Code	Description	Gauge
L5273	CMDI DETACHABLE KEY BIT 5	



Slip Bit SMPI Pin Safe Blank

Product Code	Description
L5271	SMPI DETACHABLE BIT

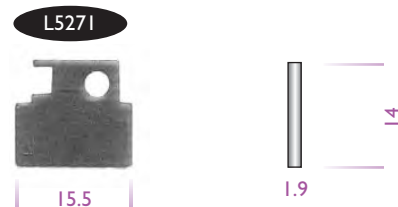

PIN SAFE - MFR

Chubb 3G Long Pin Safe Blank

Product Code	Description	Gauge
AS11280	3GS LONG	3



SLS 3G Pin Safe Blank

Product Code	Description	Gauge
AS11265	3GS SLS	3





## SLS Long 3G Pin Safe Blank

Product Code	Description	Gauge
ASI1277	3GS SLS LONG	3

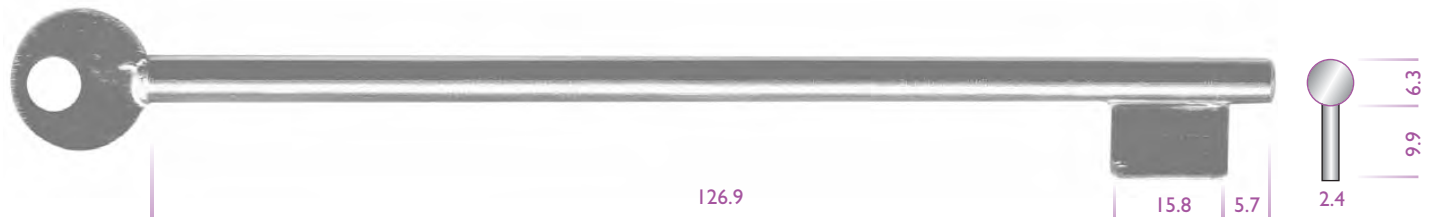

## SMP 3G Pin Safe Blank

Product Code	Description	Gauge
ASI1278	3GS SMP	3



## PIPE SAFE - MFR

### Lips Pipe Safe Blank

Product Code	Description	Gauge
ASI1113	LIPS	10



### Lips Long Pipe Safe Blank

Product Code	Description	Gauge
ASI1112	LIPS	10



See page 28 for Lips Double Bitted

5ME1 Double Bitted Pipe Blank

Product Code	Description	Gauge
7970	5ME1 DBIT	11

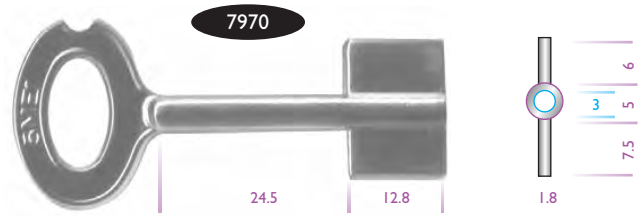

5ME2 Double Bitted Pipe Safe Blank

Product Code	Description	Gauge
7872	5ME2 DBIT	9

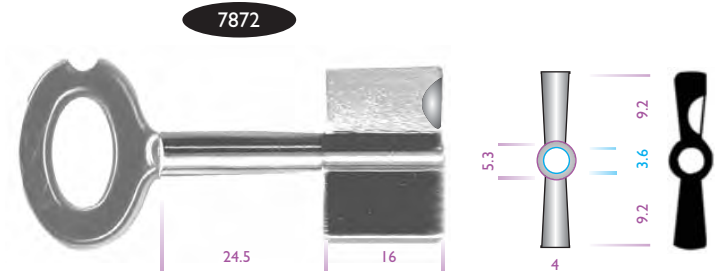

5ME3 Double Bitted Pipe Safe Blank

Product Code	Description	Gauge
L5294	5ME3 DBIT	9



8372 TA Double Bitted Pipe Safe Blank

Product Code	Description	Gauge
L14262	Double bitted safe	9



8626 Double Bitted Pipe Safe Blank

Product Code	Description	Gauge
L761	8626 DOUBLE BITTED PIPE I I	

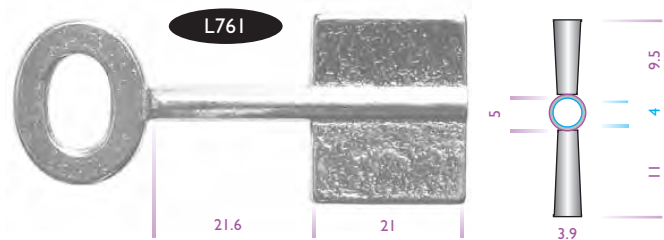

FD Double Bitted Pin Safe Blanks

Product Code	Description	Gauge
L762	FD	5.5



# DOUBLE BITTED SAFE - TYPE

## FQL Double Bitted Squire Pin Mortice Blank

Product Code	Description	Gauge
L768	FQL	7

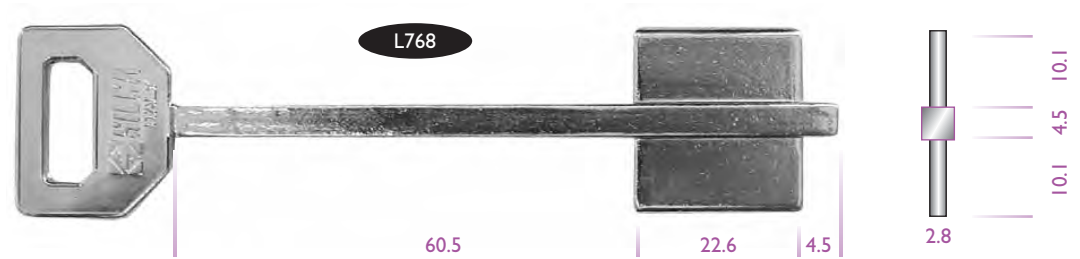

## LM721 I Double Bitted Pin Safe Blank

Product Code	Description	Gauge
6992	LM721 I	5



## LM 821 I Double Bitted Pipe Safe Blank

Product Code	Description	Gauge
6995	LM821 I	10



## LM 8712 Double Bitted Pipe Safe Blank

Product Code	Description	Gauge
7036	LM8712	9



# DOUBLE BITTED SAFE - MFR

## CSCP Double Bitted Pin Safe Blanks

Product Code	Description	Gauge
2911	CSCP	4

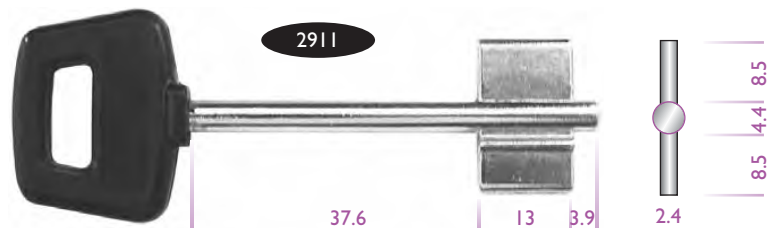

**CSLC Double Bitted Pin Safe Blank**

Product Code	Description	Gauge
L765	CSLC	6

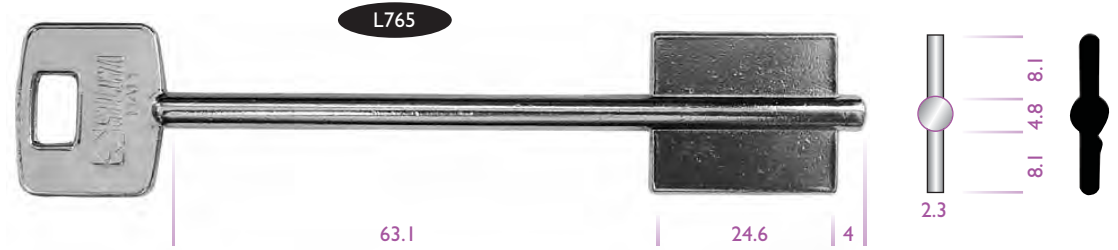

**CSL Double Bitted Pin Safe Blank**

Product Code	Description	Gauge
L766	CSL	6

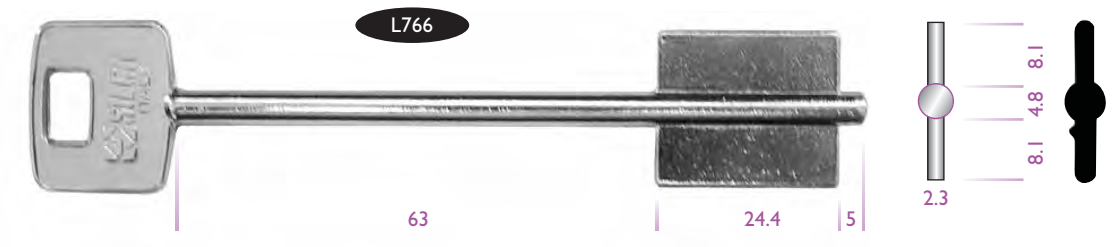

**JW20 Double Bitted Pin Safe Blank**

Product Code	Description	Gauge
L3299	JW20 DOUBLE BITTED PIN 6.9	

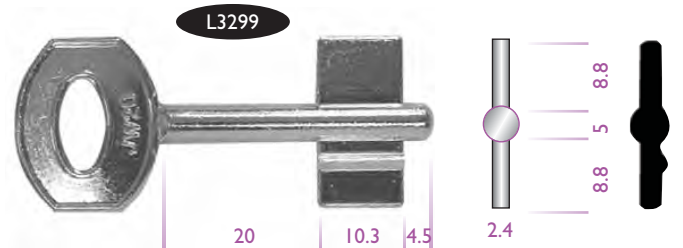

**JW60 Double Bitted Pin Safe Blank**

Product Code	Description	Gauge
L41	JW60 DOUBLE BITTED PIN 6	

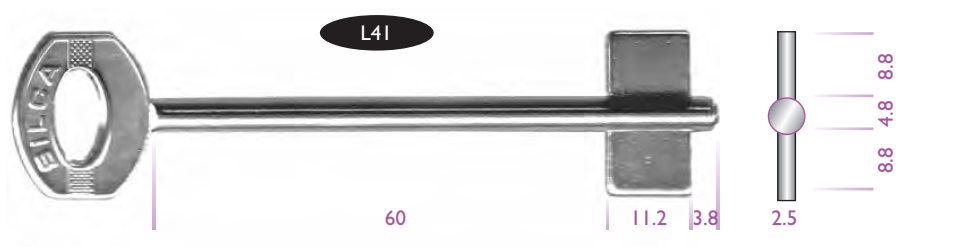

**JW90 Double Bitted Pin Safe Blank**

Product Code	Description	Gauge
L40	JW90 DOUBLE BITTED PIN 6	

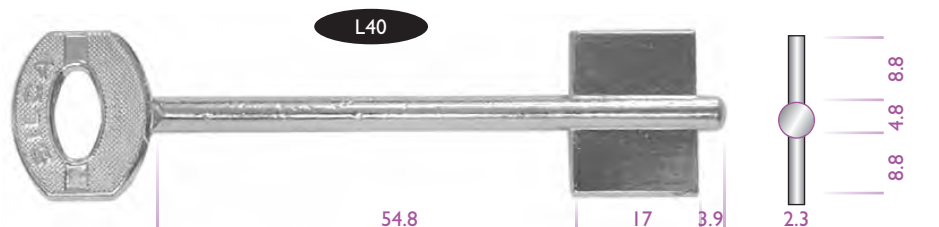

# DOUBLE BITTED SAFE - MFR

## Lips Double Bitted Pin Safe Blank

Product Code	Description	Gauge
ASI1301	LIPS DOUBLE	9



## Mauer 88801 164mm Double Bitted Pin Safe Blank

Product Code	Description	Gauge
LI1617	88801 MAUER - GEN	10



## Mauer 88802 164mm Double Bitted Pin Safe Blank

Product Code	Description	Gauge
LI1619	88802 MAUER - GEN	10



## Mauer 88812 120mm Double Bitted Pin Safe Blank

Product Code	Description	Gauge
LI1618	88812 MAUER - GEN	10



## Mauer 88813 120mm Double Bitted Pin Safe Blank

Product Code	Description	Gauge
LI1620	88813 MAUER - GEN	10



Pin Cabinet Blanks

Product Code	Description	Gauge
ASI1065	6GC	6
ASI1072	7GC	7
ASI1088	8GC	8
ASI1093	9GC	9

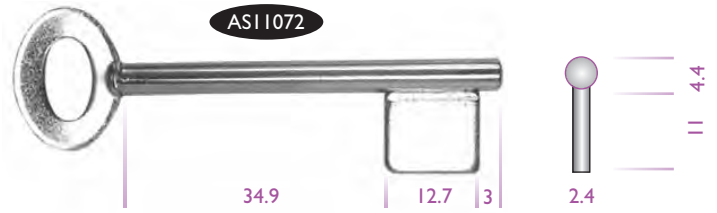

PIPE CABINET - TYPE

No 82 Small Cupboard Cabinet Blanks

Product Code	Description	Gauge
ASI1080	10GT82	10
ASI1081	9GT82	9



No 83 Medium Cabinet Pipe Blanks

Product Code	Description	Gauge
ASI1002	8GC MED	8
ASI1003	9GC MED	9
ASI1000	10GC MED	10
ASI1004	11GC MED	11
ASI1001	12GC MED	12



No 84 Large Cabinet Pipe Blanks

Product Code	Description	Gauge
ASI1082	10GC LONG	10
ASI1083	11GC LONG	11
ASI1084	7GC LONG	7
ASI1085	8GC LONG	8
ASI1086	9GC LONG	9



Malleable Pipe Cabinet Blanks

Product Code	Description	Gauge
ASI1269	10GC	10
ASI1268	11GC	11
ASI1270	9GC	9



6605 Pipe Cabinet Blank

Product Code	Description	Gauge
L935	6605	8





# PIPE CABINET - TYPE

## 6606 Pipe Cabinet Blank

Product Code	Description	Gauge
L478	6606	7

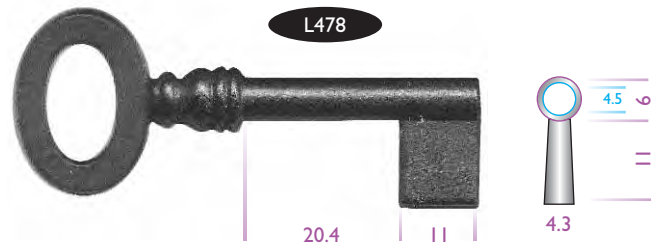

## 6607 Pipe Cabinet Blank

Product Code	Description	Gauge
L934	6607	7



## 3F 1540 Fancy Bow Pipe Cabinet Blank

Product Code	Description	Gauge
L471	3F 1540	9



## 3F 2635 Fancy Bow Pipe Cabinet Blank

Product Code	Description	Gauge
L473	3F 2635	9



## 3F 4832 Fancy Bow Pipe Cabinet Blank

Product Code	Description	Gauge
L472	3F 4832	9



## 3F 4842 Fancy Bow Pipe Cabinet Blank

Product Code	Description	Gauge
L474	3F 4842	10



3F 1640 Fancy Bow Pipe Cabinet Blank

Product Code	Description	Gauge
L670	3F 1640	9



3F 3340 Fancy Bow Pipe Cabinet Blank

Product Code	Description	Gauge
L14515	3F 3340	9



3M 1630 Fancy Bow Pipe Cabinet Blank

Product Code	Description	Gauge
7609	3M 1630	10

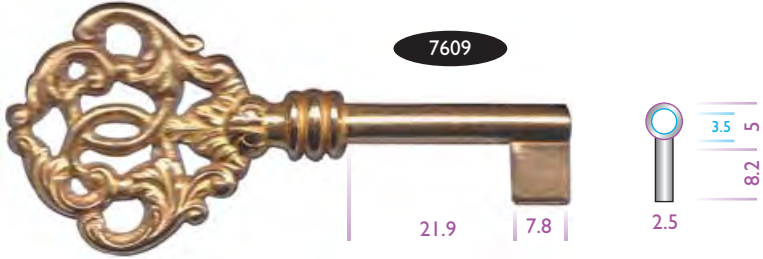

3M 2734 Fancy Bow Pipe Cabinet Blank

Product Code	Description	Gauge
L1488	3M 2734	10



3M 3437 Fancy Bow Pipe Cabinet Blank

Product Code	Description	Gauge
L1487	3M 3437	10

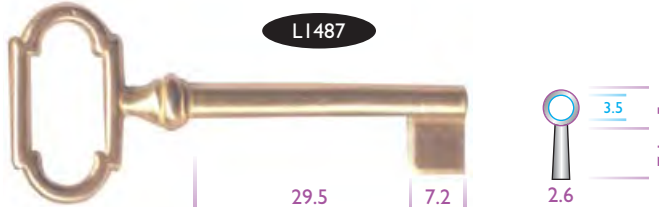

3M 2630 Fancy Bow Pipe Cabinet Blank

Product Code	Description	Gauge
1717	3M 2630	10

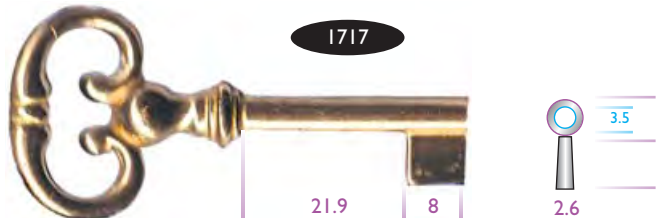

# MALEABLE IRON

## No 2 Malleable Iron Blank

Product Code	Description
ASI 1284	No. 2 MAL

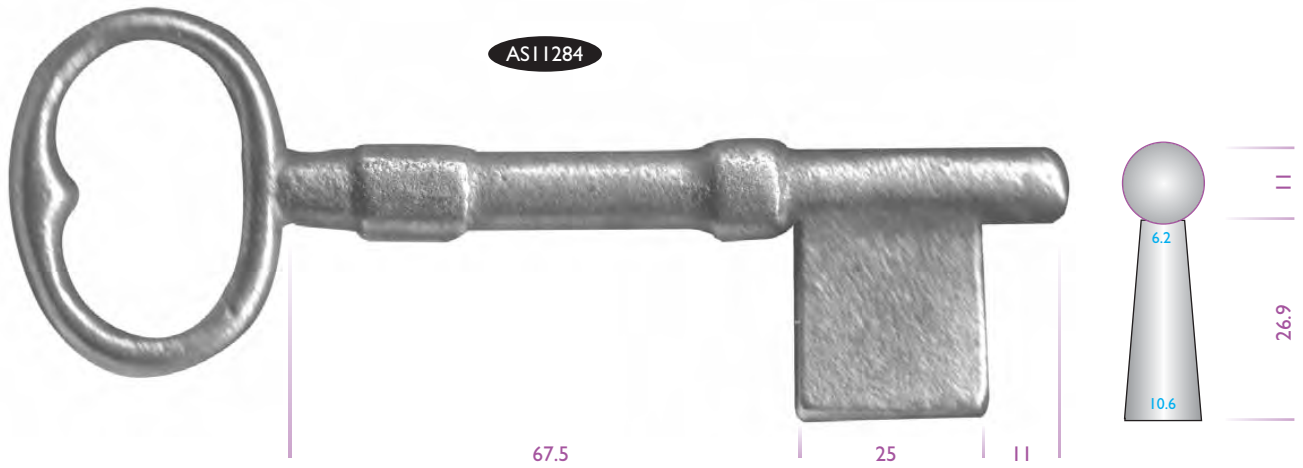

## No 3W Malleable Iron Blank

Product Code	Description	Gauge
ASI 1285	No. 3 MAL	



## No 4 Malleable Iron Blank

Product Code	Description	Gauge
ASI 1286	No. 4 MAL	



**No 8 Malleable Iron Blank**

Product Code	Description	Gauge
ASI1287	No. 8 MAL	



**No 10 Malleable Iron Blank**

Product Code	Description	Gauge
ASI1288	No. 10 MAL	



**No 23TN Malleable Iron Blank**

Product Code	Description	Gauge
ASI1289	No. 23 THIN	

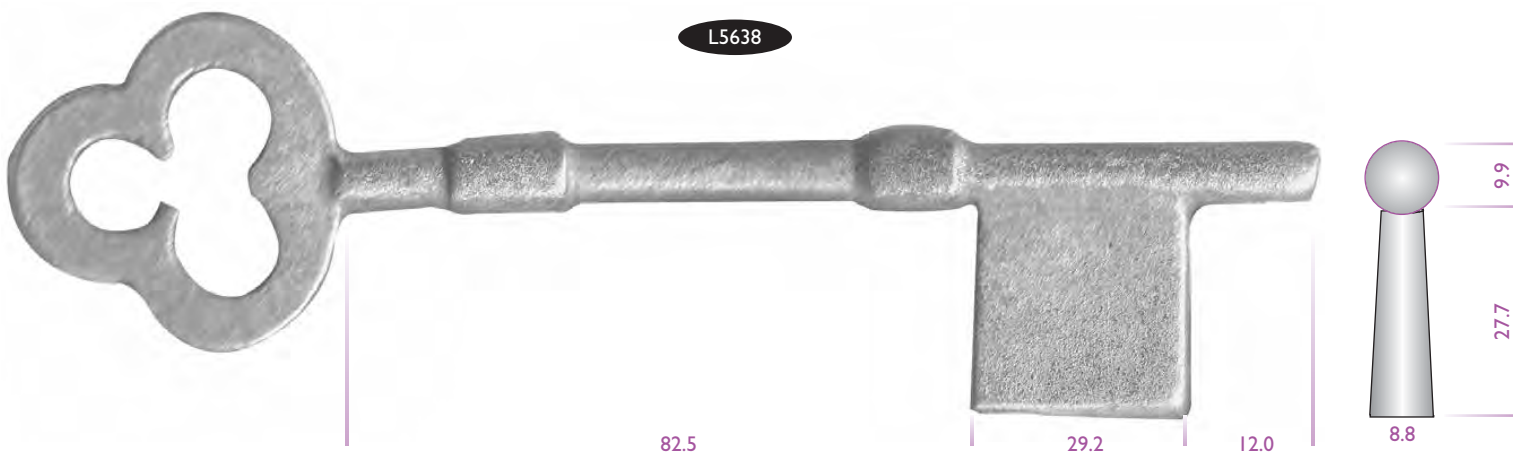

# MALEABLE IRON

## No 23TK Malleable Iron Blank

Product Code	Description	Gauge
ASI1290	No. 23 THICK	



## No 41 Malleable Iron Blank

Product Code	Description	Gauge
ASI1291	No. 41 MAL	

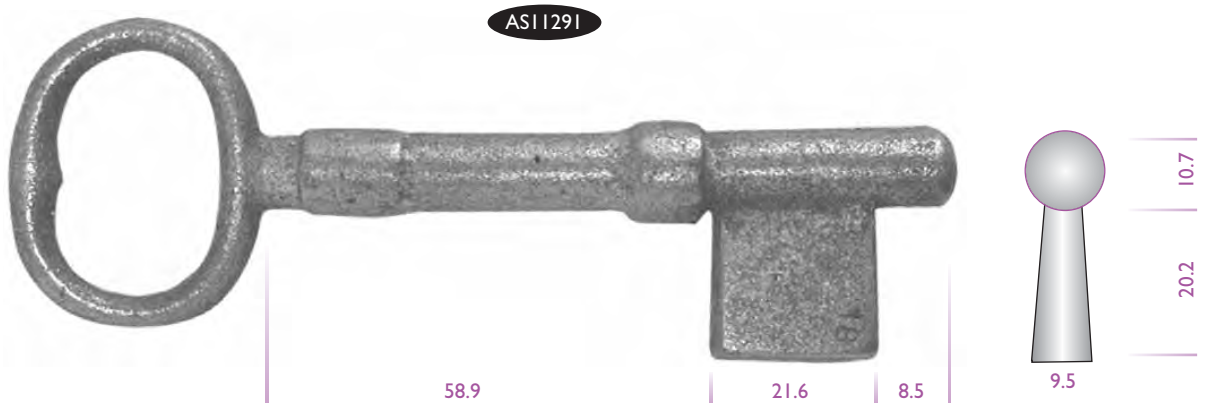

## No 47 Malleable Iron Blank

Product Code	Description	Gauge
ASI1292	No. 47 MAL	

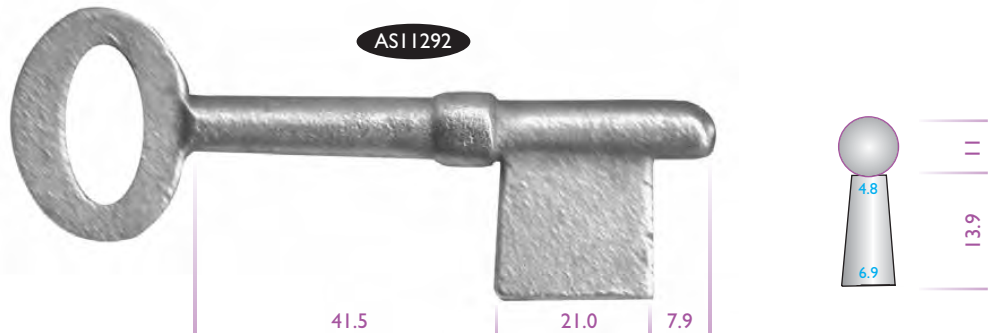

No 93 Malleable Iron Blank

Product Code	Description	Gauge
ASI1293	No. 93 MAL	

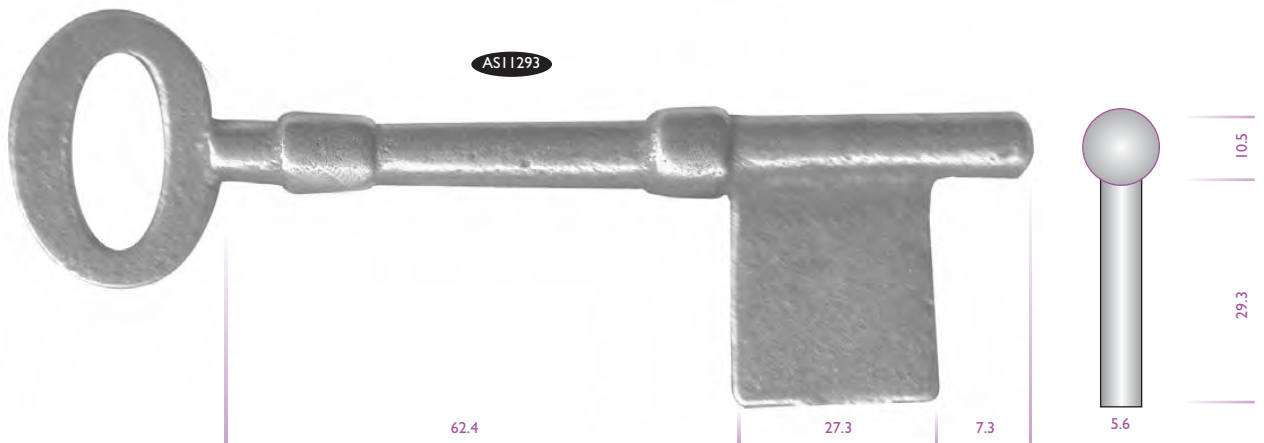

No 94 Malleable Iron Blank

Product Code	Description	Gauge
ASI1294	No. 94 MAL	





## 18th Cylinder

Product Code	Description
ASI1271	18TH CYLINDER PRESENTATION KEY
ASI1274	21ST CYLINDER PRESENTATION KEY



## 18th Mortice

Product Code	Description
ASI1273	PRESENTATION 18TH MORTICE KEY
ASI1272	PRESENTATION 21TH MORTICE KEY



# NOTES

---

# NOTES

---

# NOTES

---

# INDEX

## ● Double Bitted Safe

Double bitted Safe - Type 25

5ME1, 5ME2, 5ME3, 8372, 8626, FD Double, Squire, Lm8211, LM8712

Double bitted Safe - MFR 26 - 28

CSCP, CSLC, CSL, JW20, JW60, JW90, Lips Double, LM7211, Mauer 88801, Mauer 88802, Mauer 88812, Mauer 88813

## ● Flat Steel Blanks

Flat Steel - Type 21

Flat 25 25mm, Flat 38 38mm, Flat 50 50mm

## ● Gate Blanks

Gate Blanks 11 - 12

19mm Gate, Boswick No1 Ward

## ● Maleable Iron

Maleable Iron 29 - 32

N04, No8, No10, No23TN, No23TK, No41, No47, No93, No94

## ● Mortice Blanks

Mortice (Type) 1

11mm Mortice, 13mm Mortice, 16mm Mortice, 2L Warded Mortice

Mortice Manufacturer (MFR) 1 - 10

ACE, Asec, Aldridge, Chubb, Elementa, ERA, Erebus, Euro, Fleet, Gibbons, Guardian, Ingersoll, Legge, Merchant, Morgan, Securefast, Union, Wellington, Willenhall, Worrell, Yale

## ● Pin Cabinet

Pin Cabinet - Type 29 - 32

6605, 6606, 6607, No 82 Small, No 83 Medium, No 84 Large, Malleable Pipe, 3F 1540, 3M 1630, 3F 1640, 3M 2630, 3F 2635, 3M 2734, 3M 3437, 3F 4832, 3F 4842

## ● Pin Padlocks

Pin Padlock - Type 17 - 18

8G Pin Padlock

Pin Padlock - MFR 18 - 19

Chubb, Safe Guards, Squire

## ● Pipe Padlocks

Pipe Padlock - MFR 17 - 18

Aldridge, Chubb, ERA, Squire

## ● Pre - Cut Blanks

Pre - Cut Mortice 12 - 15

Asec, Euro, Gibbons, Legge, Union, Yale

Pre - Cut Rim 15 - 16

Fire Brigade, Gibbons, Rader, Union

Pre - Cut Padlock 16

Fire Brigade

Pre - Cut Master Keys 17

Lowe & Fletcher, Union

Pre - Cut Wardrobe 17 - 18

Ashtree, Asro, Ringbow

## ● Presentation

Presentation 36

18th cylinder, 18th Mortice, 21st Cylinder, 21st Mortice

## ● Pipe Cabinet

Pin Cabinet - Type 29 - 31

## ● Pin Safe

Pin Safe - Type 21 - 22

19mm Bit Safe, 25mm Bit Safe, Drawer Long 5G, Long 6.5G, Extra long pin Safe

Pin Safe - MFR 23 - 24

Chubb, SLS 3G, SMP 3G,

## ● Pipe Safe

Pipe Safe - MFR 24

Lips pipe, Lips Long

## ● Rim Blanks

Rim (Type) 10

16mm Bit Rim, 19mm Bit Rim

Rim Manufacturer (MFR) 1 - 10

Union

## ● Slip Bits

Pipe Safe - MFR 23

# HOW TO FIND ALDRIDGE

## Aldridge Security - London

Silca House  
32-34 Eagle Wharf Road  
London,  
N1 7EB  
T: 08444 125 101  
F: 0800 137 933  
E: sales@aldridgesecurity.co.uk



## Aldridge Security - Manchester

Neville Hamilton House  
50 Queen Street  
Salford, Manchester  
M3 7DQ  
T: 08444 125 101  
F: 0800 137 932  
E: sales@aldridgesecurity.co.uk



Calling from Republic of Ireland:

T: 01 647 0048

F: 01 647 0049



If you would like a more detailed map regarding our locations please contact  
Aldridge Marketing on 0161 828 0868

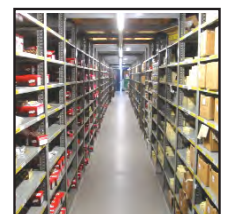
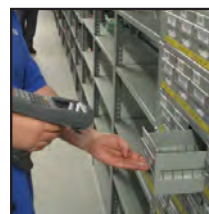
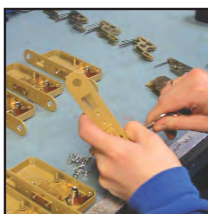
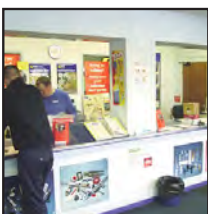

Visit our website at [www.aldridgesecurity.co.uk](http://www.aldridgesecurity.co.uk) - Email us at [sales@aldridgesecurity.co.uk](mailto:sales@aldridgesecurity.co.uk)





# ALDRIDGE

MASTERS OF SECURITY DISTRIBUTION

E. Aldridge & Son (Locksmiths) Ltd  
Silca House  
32 - 34 Eagle Wharf Rd  
London, N1 7EB  
t: 08444 125 101  
f: 0800 137 933

E. Aldridge & Son (Locksmiths) Ltd  
Neville Hamilton House  
50 Queen St, Salford  
Manchester, M3 7DQ  
t: 08444 125 101  
f: 0800 137 932

Calling from the Republic of Ireland 01 647 0048, fax 01 647 0049  
Email: [sales@aldridgesecurity.co.uk](mailto:sales@aldridgesecurity.co.uk)  
[www.aldridgesecurity.co.uk](http://www.aldridgesecurity.co.uk)